

NEW
IMPROVED BUTTON CONTROLS

FIRST·LIGHT
USA



TOMAHAWK® MC
USER MANUAL



TABLE OF CONTENTS



| | |
|---------------------------------------|-----|
| Specifications | 1 |
| Components | 4 |
| Battery Installation | 4 |
| Basic Functions | 5 |
| Lockout/Ready Mode..... | 5 |
| Momentary Mode..... | 5 |
| Primary Control..... | 6 |
| Secondary Control..... | 6 |
| Secondary Color Selection | 7 |
| Double-Click for Color | 7 |
| Low Battery Indication | 8 |
| Finger Loop | 8-9 |
| Steel Belt Clip..... | 10 |
| Tactical Retention System (TRS) | 11 |
| Lifetime Limited Warranty..... | 12 |

FIRST-LIGHT USA, LLC

205 S. Main Street, Seymour, IL 61875
 Phone: 877.454.4450 | Fax: 877.454.4420
 Email: info@firstlight-usa.com
www.firstlight-usa.com

SPECIFICATIONS

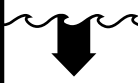
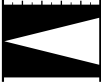
| FL1 STANDARD | MAX | HIGH | MEDIUM | LOW |
|---|-----------------------|-----------------------|----------------------|---------------------|
|  | 425 LUMENS | 175 LUMENS | 50 LUMENS | 5 LUMENS |
|  | 2h | 4h | 16h | 60h |

| FL1 STANDARD | | | |
|---|---|---|---|
|  |  |  |  |
| 3m | 1m | 220m | 12,150cd |

Batteries

- (2) CR123 3-Volt Lithium Batteries, ANSI: 5018LC, IEC: CR17345

Environmental Specifications

- Normal Operating Temperatures: (-20°F) to 120°F
- Waterproof

Thank you for purchasing the First-Light USA Tomahawk® MC Tactical Light. Please carefully review this manual prior to use.

IMPORTANT – PLEASE READ FIRST

The intense white light emitted by the primary white LED may cause temporary blinding, regardless of the brightness level used. Use caution during operation. Do not point light directly into eyes at any distance. Not for use by children.

LITHIUM BATTERY WARNING

Lithium batteries can be dangerous if used improperly. Never disassemble, short circuit, recharge, or expose to water, fire, or high temperatures. Never use batteries of different ages, capacities, or brands together. Store separately and properly dispose of batteries after use. Keep away from children.

NOTE: High quality, rechargeable CR123 batteries may be used to power the Tomahawk MC Tactical Light. The user should identify the voltage capacity of any rechargeable batteries prior to installing them into the Tomahawk MC Tactical Light.



IMPORTANT: Never install any rechargeable CR123 batteries that exceed a combined voltage of 10 volts as this will damage the internal circuitry and void the warranty.

REPLACEMENT PARTS

To order replacement parts, please call 877.454.4450 or visit www.firstlight-usa.com.

COMPONENTS

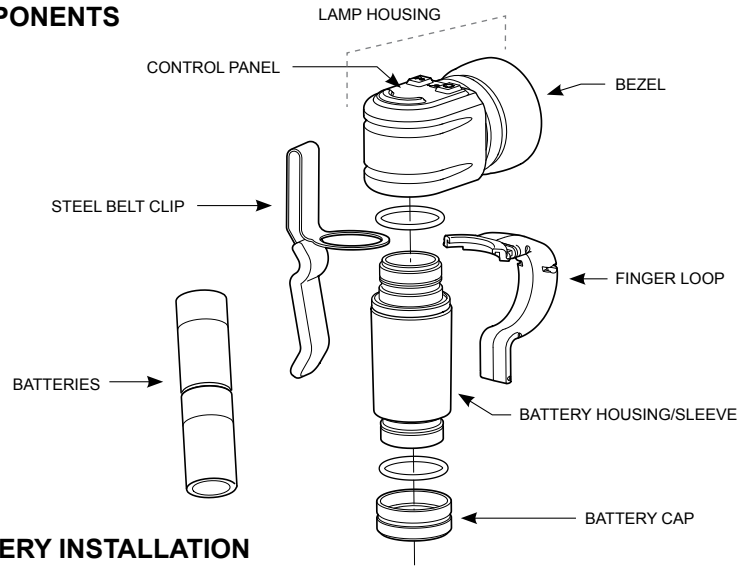

BATTERY INSTALLATION



- STEP 1.** Remove battery cap. Insert two batteries “+” terminals first (as shown above).
- STEP 2.** Reinstall battery cap. Hand-tighten until snug.
- STEP 3.** Ensure batteries are properly installed by pressing any button on the control panel. The red LED “lock” should illuminate indicating the light is in Lockout Mode. If it does not, repeat Steps 1 and 2, ensuring both “+” terminals are facing up.

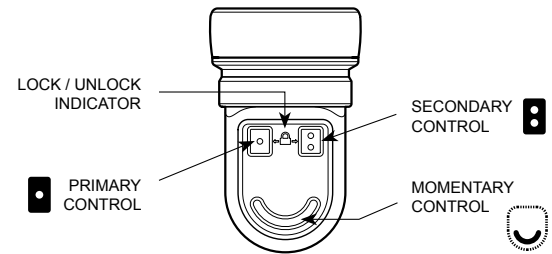

BASIC FUNCTIONS

Control Panel Diagram





LOCKOUT/READY MODE

The Tomahawk® MC is factory-shipped in Lockout Mode, a setting for preventing accidental illumination. To unlock the light and enter Ready Mode, press the  and  buttons simultaneously and release. The green “unlock” indicator illuminates signaling that visible light modes are active.

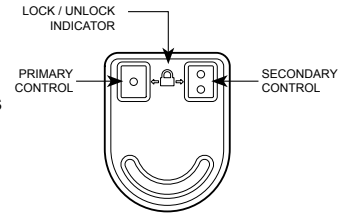
To re-enter Lockout Mode at any time during use, press and hold the  and  buttons simultaneously until the red “lockout” indicator illuminates, then release.



MOMENTARY CONTROL BUTTON

Pressing the  button will turn on the white LED in maximum output. Releasing the  button will turn off the white LED.

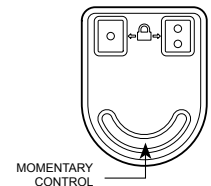

PRIMARY CONTROL BUTTON

To turn on the primary (white) LED, press and release the **Q** button. To adjust the brightness of the primary LED, from the on position, press and hold the **Q** button. Release the **Q** button at the desired brightness. To turn off the primary LED, press and release the **Q** button.

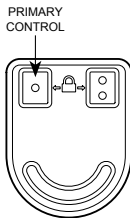

SECONDARY COLOR SELECTION

From the off position, press and hold the **Q** button to cycle between the secondary LED color options. Release the **Q** button at the desired color.

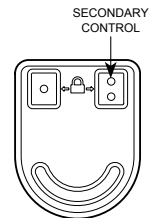

SECONDARY CONTROL BUTTON

To turn on the secondary (color) LEDs, press and release the **Q** button. To adjust the brightness of the secondary LEDs, press and hold the **Q** button. Release the **Q** button at the desired brightness. To turn off the secondary LEDs, press and release the **Q** button.

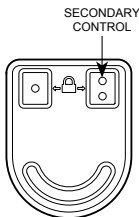

DOUBLE-CLICK FOR COLOR

While in Lockout Mode the colored LEDs can be activated by double-clicking the **Q** button. This illuminates the secondary color LEDs in the lowest brightness setting and disables the primary white LED. Adjust the brightness by pressing and holding the **Q** button. When the color LEDs are turned off, the light will return to Lockout Mode.

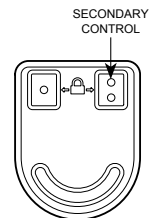

LOW BATTERY

When the battery nears the end of its useful life the red Lock/Unlock indicator will begin to flash. Once the useful life of the batteries has been reached the Tomahawk® MC will begin to limit its output in order to extend run time.

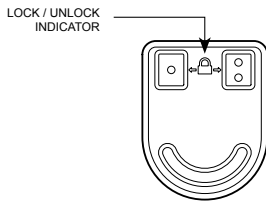

FINGER LOOP

Your Tomahawk MC comes equipped with a Finger Loop installed in a neutral/straight-forward position. In order to enhance the ergonomic control of the Tomahawk MC, it is recommended that the Finger Loop be slightly offset to better align the thumb with the control panel.

The Finger Loop can be moved by pushing it to the desired position.

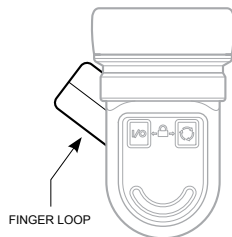

INSTALLING FINGER LOOP

A smaller Finger Loop is also provided. In order to install the smaller Finger Loop, loosen the threaded connection between the lamp housing and battery housing until the large Finger Loop is loosened to a point at which it can be removed. Insert the collar of the smaller Finger Loop so that it is seated within the machined groove located at the top of the battery housing.

! **IMPORTANT:** Ensure that the Finger Loop remains securely seated during use. Hand-tighten the connection between the battery housing and lamp housing as firmly as possible.

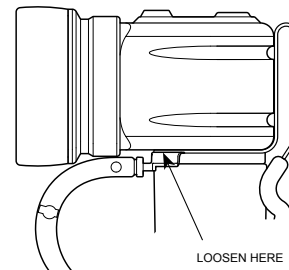

TOMAHAWK® MC STEEL CLIP (IF EQUIPPED)

The Tomahawk MC Steel Clip can be adjusted to any desired position by loosening the connection between the battery housing and the lamp housing to the point where the Steel Clip can be moved.

Move the Steel Clip to the desired position and re-tighten the connection.

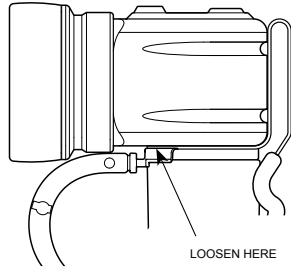

MOLLE/PALS Webbing Attachment

The Tomahawk MC MOLLE Steel Clip is specially designed to attach securely to MOLLE/PALS webbing. See Figure A to view suggested mounting option.

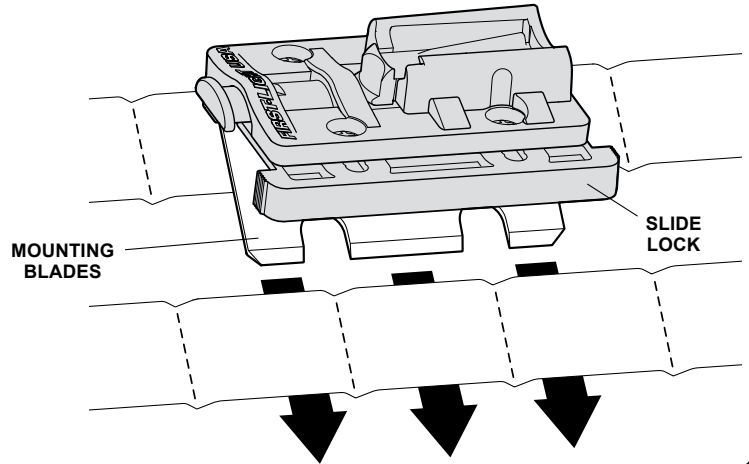

Figure A: MOLLE Steel Clip attached to MOLLE/PALS webbing

TACTICAL RETENTION SYSTEM (TRS) (IF EQUIPPED)

The Tactical Retention System (TRS) will allow your Tomahawk® MC to be mounted to MOLLE/PALS webbing for hands-free use. When horizontally mounted to TRS the Tomahawk MC can be rotated nearly 180° up or down.

1. Slide the three mounting blades under the webbing loops. The two stitch lines will align with the grooves in mounting blades.
2. Insert mounting blades into the slide lock and snap into place. Ensure all three blades are secure and captured by the slide lock.
3. Slide your light (with the dovetail sleeve or panel installed) into the TRS receiver until it clicks into place.
4. To release the light, depress the button located on the top of the receiver, slide the light free from the mount.



WHEN YOUR LIGHT DEPENDS ON IT.®

www.firstlight-usa.com